



H2K

INTERNATIONAL

**1200x
2400mm**



Exceeding The Limits To Always Get The Best



1200x2400MM

PRODUCT Formats

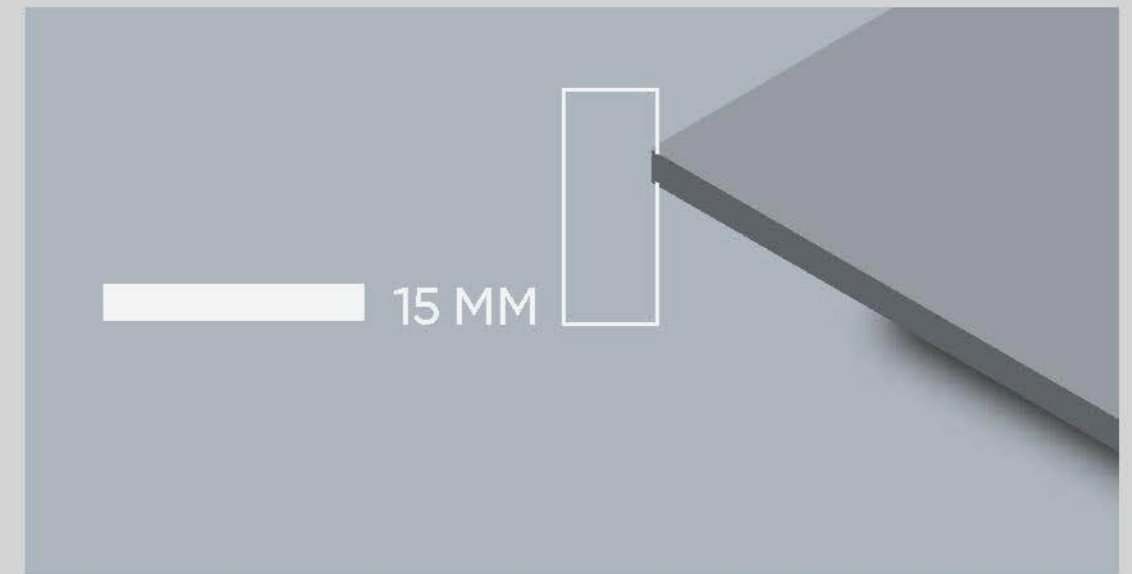
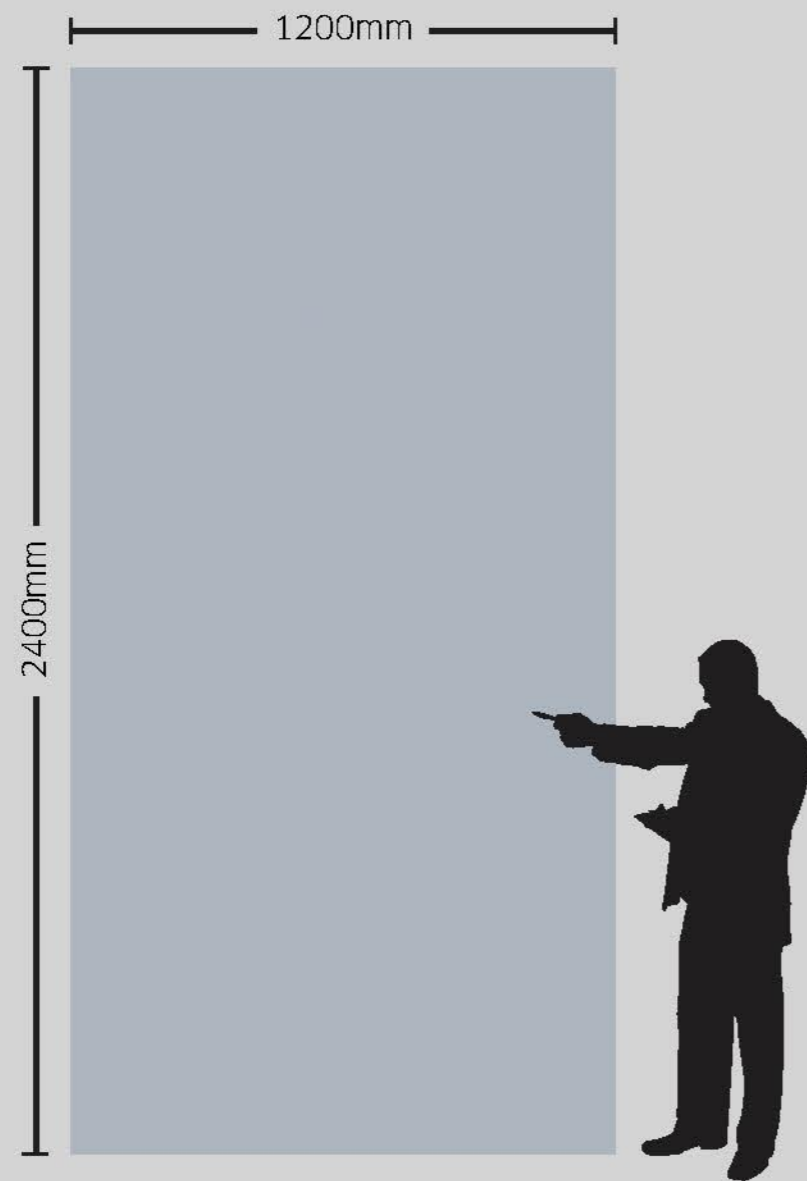

The thicknesses are one of the most important elements characterizing.

15 mm is set aside for the most demanding product applications such as kitchen countertops.

EDGE Profiles

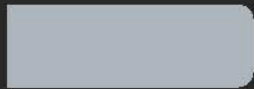

Double straight rounded edge

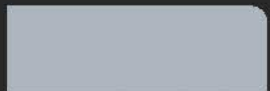

Rounded straight edge

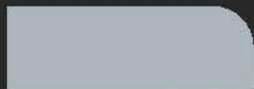

Half bullnose

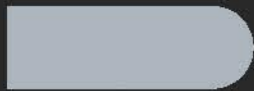

Full bullnose

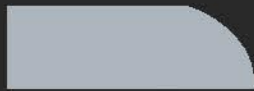

Demi bullnose

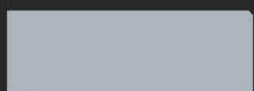

Micro bevel

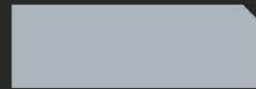

Straight squared edge



Double straight squared edge

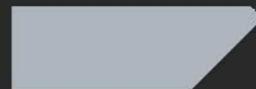

Rounded edge at 45°

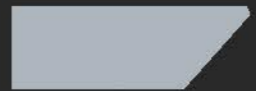

Squared edge at 45°

Giving a nice trim to the edges of the tiles adds to its beauty.

As these tiles are of the good thickness of 15mm it is possible to shape its edges in different styles and create aesthetically rich countertops for your space.

JOINT POSSIBILITIES

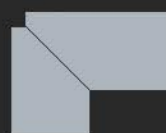

Birds beak



45° corner

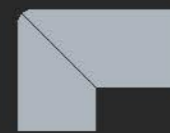

Soft corner



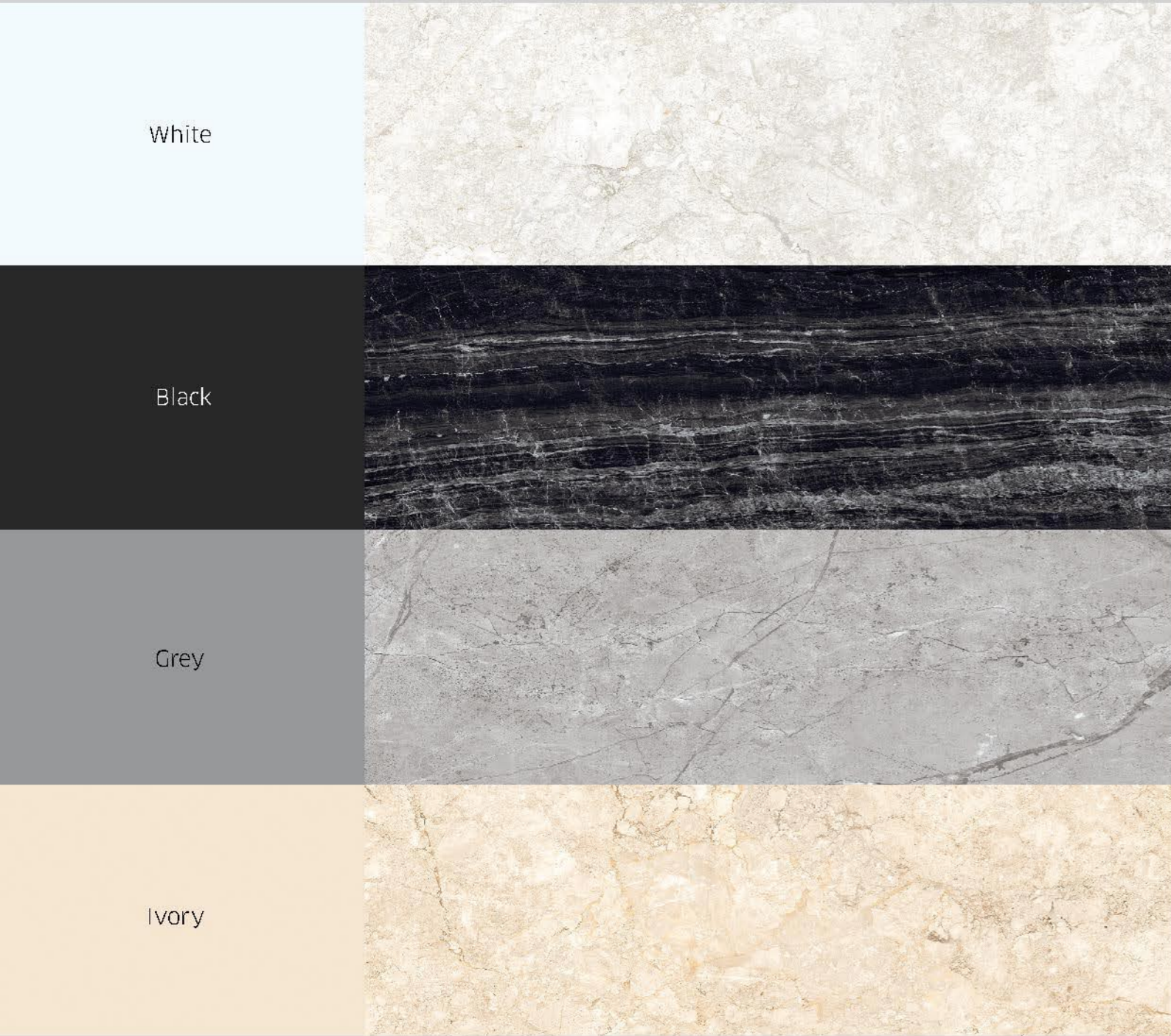

White

Black

Grey

Ivory



Our collections offer professional-grade performance while seamlessly blending the latest innovations with a premium design aesthetic that is crafted with authentic, high-quality materials.

The Functionality of
The Residential Kitchen

Elevating Classic Style
for Today's Homeowner

Leading Edge Design
and Innovation

PRODUCT Range

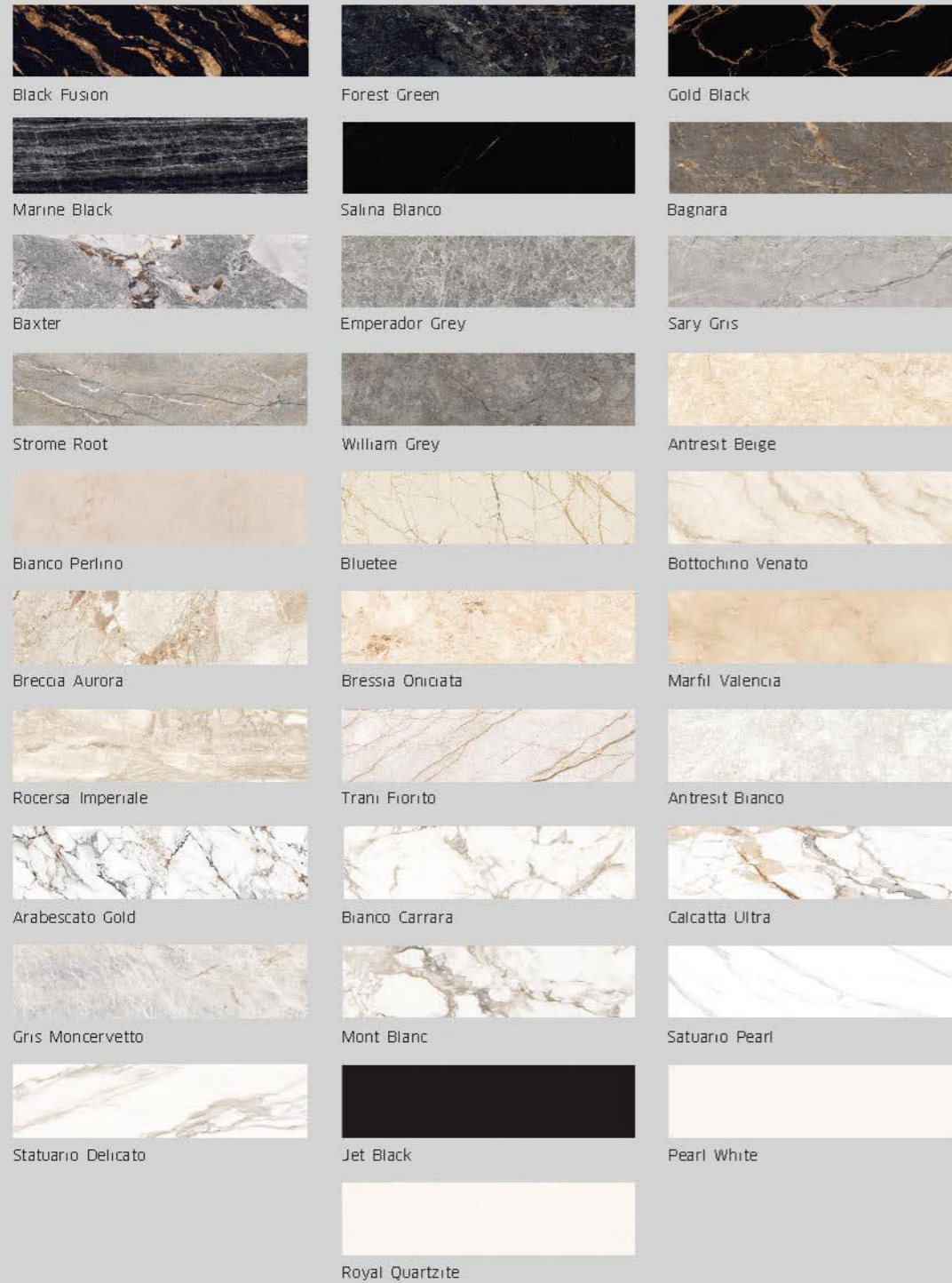

PRODUCT Finishes

GLOSSY

Glossy is an optical property which indicates how well a surface reflects light in a specular (mirror-like) direction.



APPLICATION Areas

KITCHEN COUNTERTOP



DINING TABLE



LIVING ROOM



FURNITURE



STAIRCASE



OFFICE TABLE



TABLE TOP



DOOR \ WINDOW
FRAME



TECHNICAL Features

LIGHTWEIGHT



WATERPROOF



RESISTANT TO SCRATCHES



RESISTANT TO HIGH
TEMPERATURES



EASY TO CLEAN



RESISTANT TO BENDING



100% NATURAL



RECYCLABLE



HYGIENIC



RESISTANT TO UV RAYS



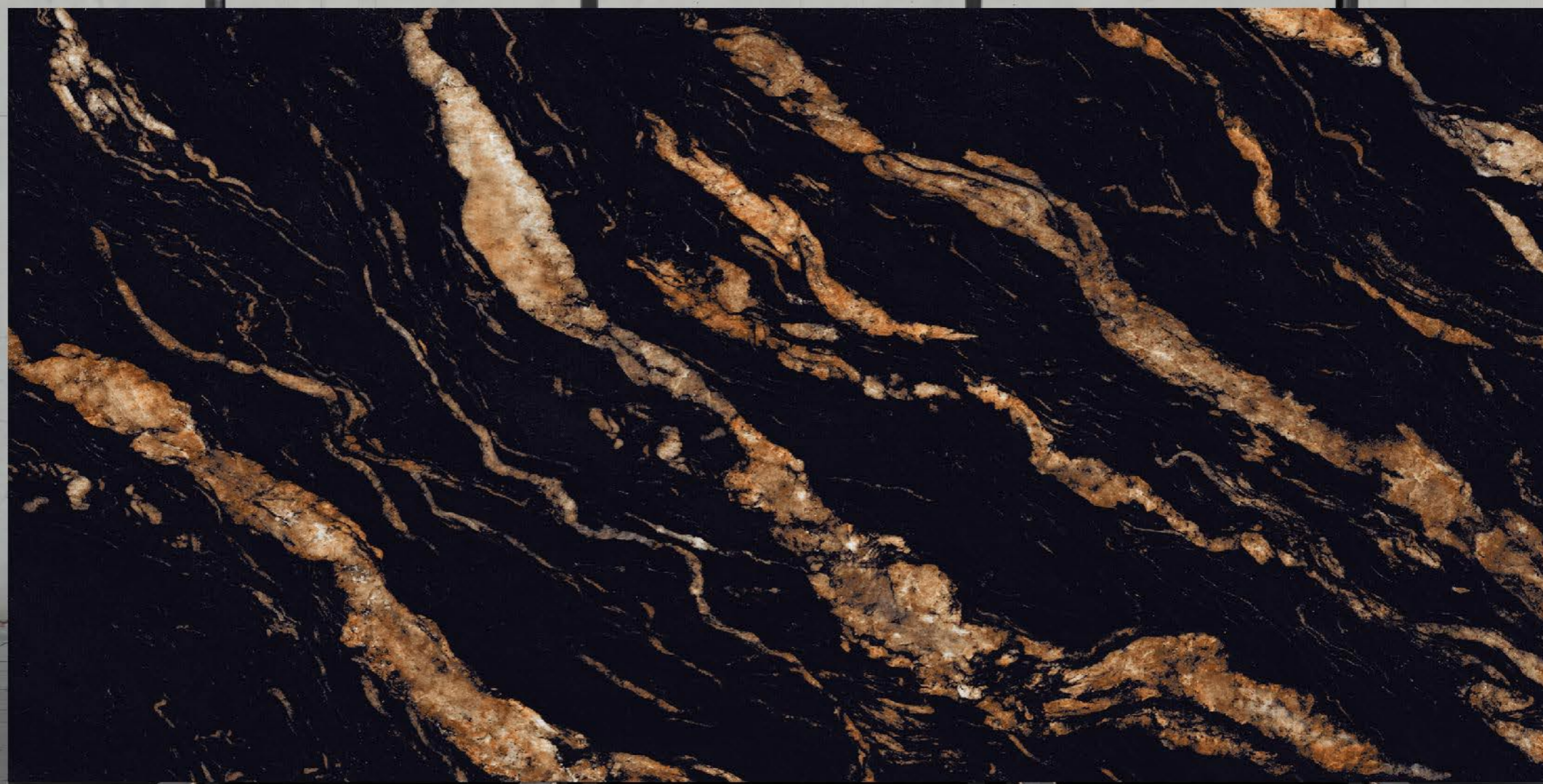

BLACK FUSION

BODY
BLACK BODY

FINISH
GLOSSY

SIZE
1200x2400 MM

THICKNESS
15 MM

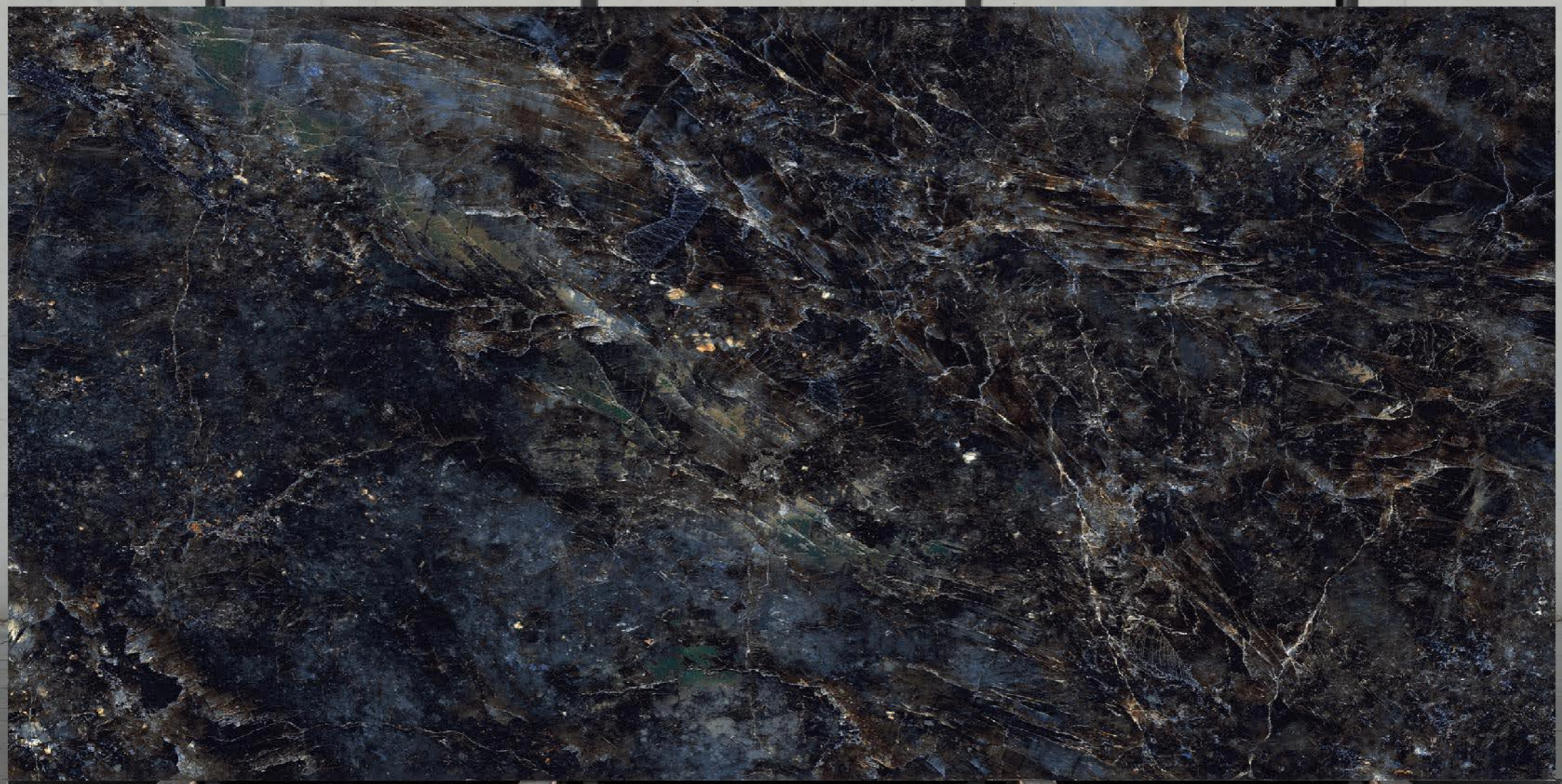

FOREST GREEN

BODY
BLACK BODY

FINISH
GLOSSY

SIZE
1200x2400 MM

THICKNESS
15 MM



GOLD BLACK

BODY
BLACK BODY

FINISH
GLOSSY

SIZE
1200x2400 MM

THICKNESS
15 MM

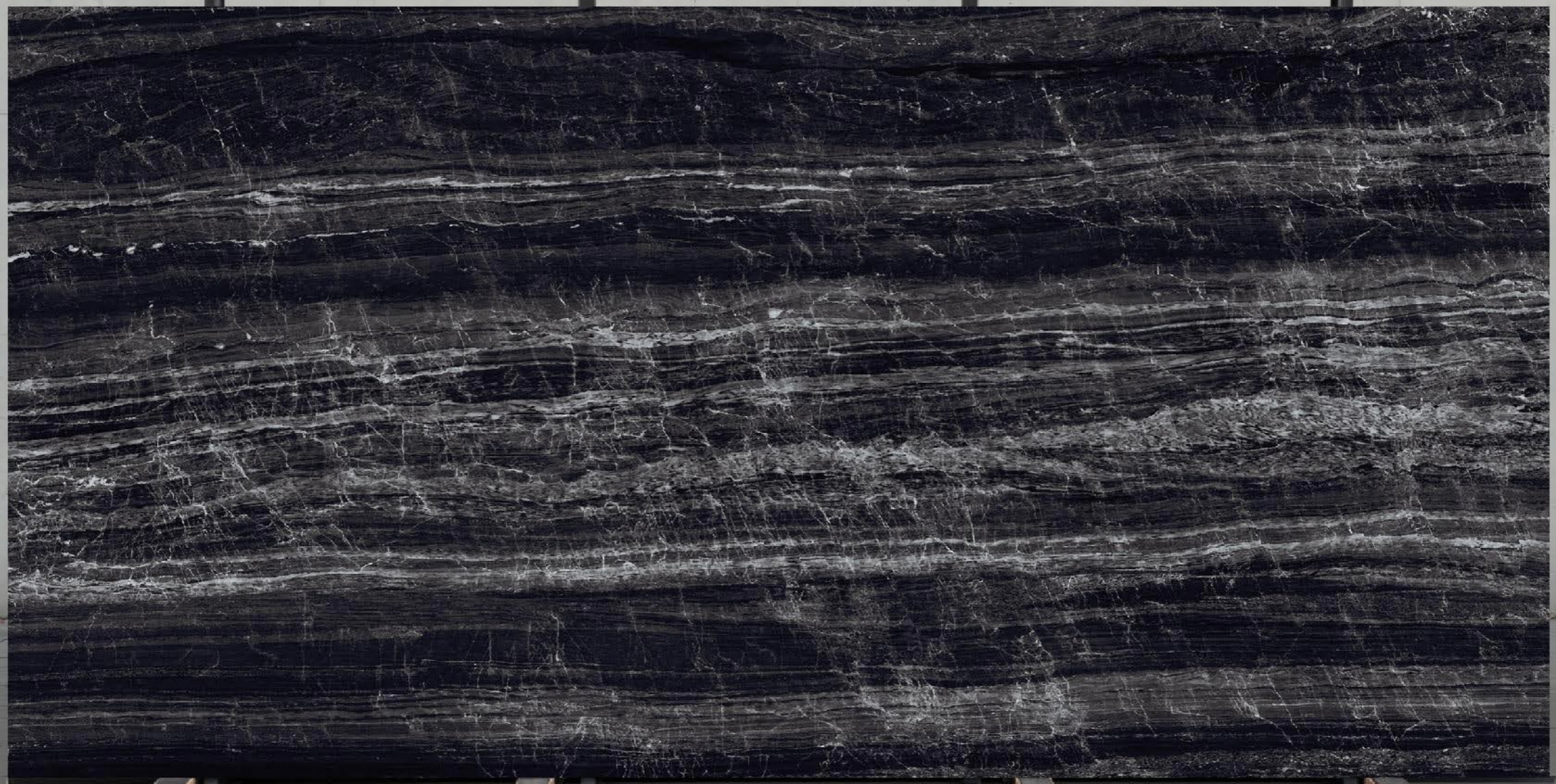

MARINE BLACK

BODY
BLACK BODY

FINISH
GLOSSY

SIZE
1200x2400 MM

THICKNESS
15 MM



SALINA BLANCO

BODY
BLACK BODY

FINISH
GLOSSY

SIZE
1200x2400 MM

THICKNESS
15 MM



BAGNARA

BODY
GREY BODY

FINISH
GLOSSY

SIZE
1200x2400 MM

THICKNESS
15 MM

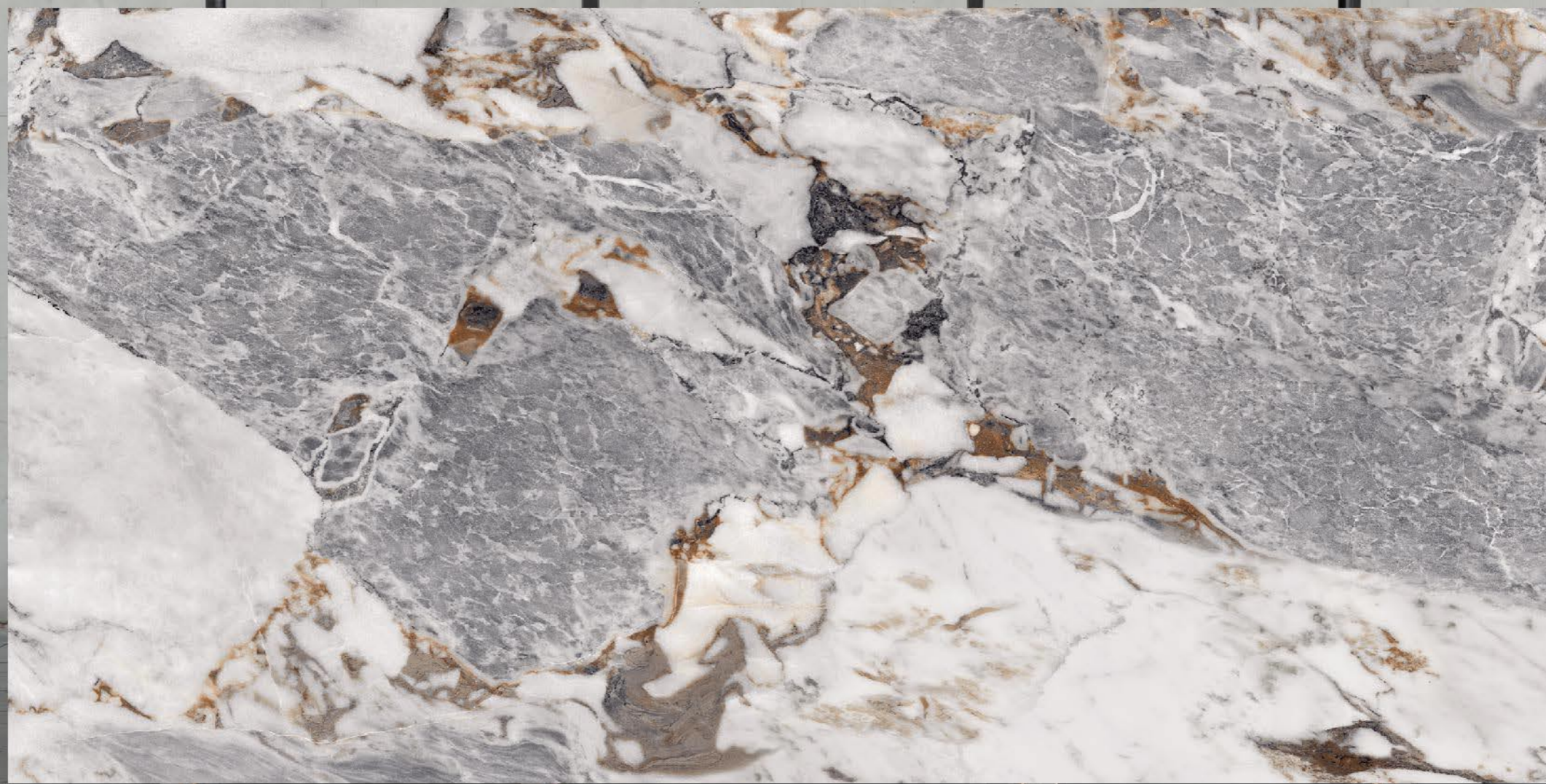

BAXTER

BODY
GREY BODY

FINISH
GLOSSY

SIZE
1200x2400 MM

THICKNESS
15 MM

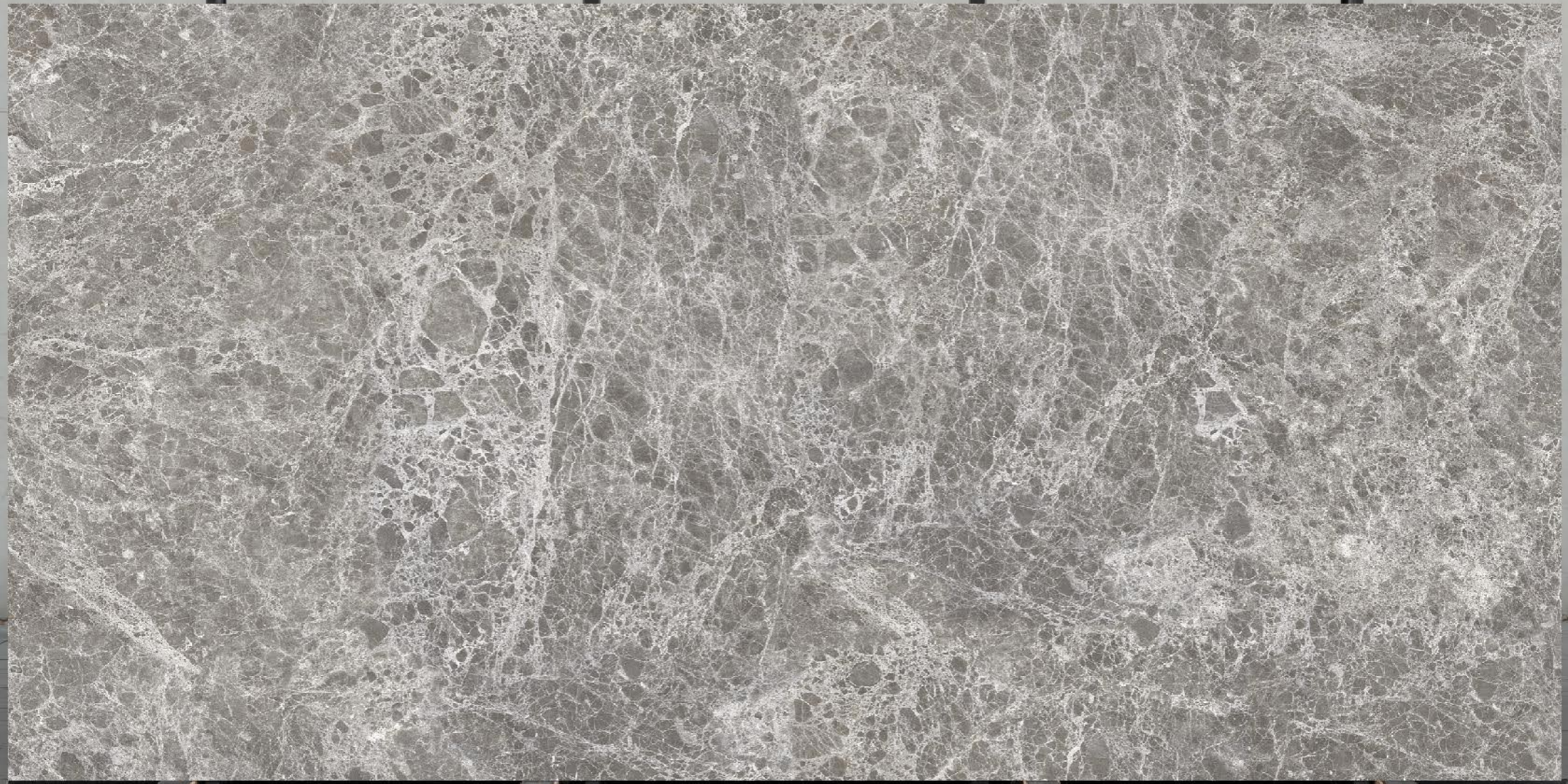

EMPERADOR GREY

BODY
GREY BODY

FINISH
GLOSSY

SIZE
1200x2400 MM

THICKNESS
15 MM



SARY GRIS

BODY
GREY BODY

FINISH
GLOSSY

SIZE
1200x2400 MM

THICKNESS
15 MM



STROME ROOT

BODY
GREY BODY

FINISH
GLOSSY

SIZE
1200x2400 MM

THICKNESS
15 MM



WILLIAM GREY

BODY
GREY BODY

FINISH
GLOSSY

SIZE
1200x2400 MM

THICKNESS
15 MM



ANTRESIT BEIGE

BODY
IVORY BODY

FINISH
GLOSSY

SIZE
1200x2400 MM

THICKNESS
15 MM



BIANCO PERLINO

BODY
IVORY BODY

FINISH
GLOSSY

SIZE
1200x2400 MM

THICKNESS
15 MM



BLUETEE

BODY
IVORY BODY

FINISH
GLOSSY

SIZE
1200x2400 MM

THICKNESS
15 MM



BOTTOCHINO VENATO

BODY
IVORY BODY

FINISH
GLOSSY

SIZE
1200x2400 MM

THICKNESS
15 MM

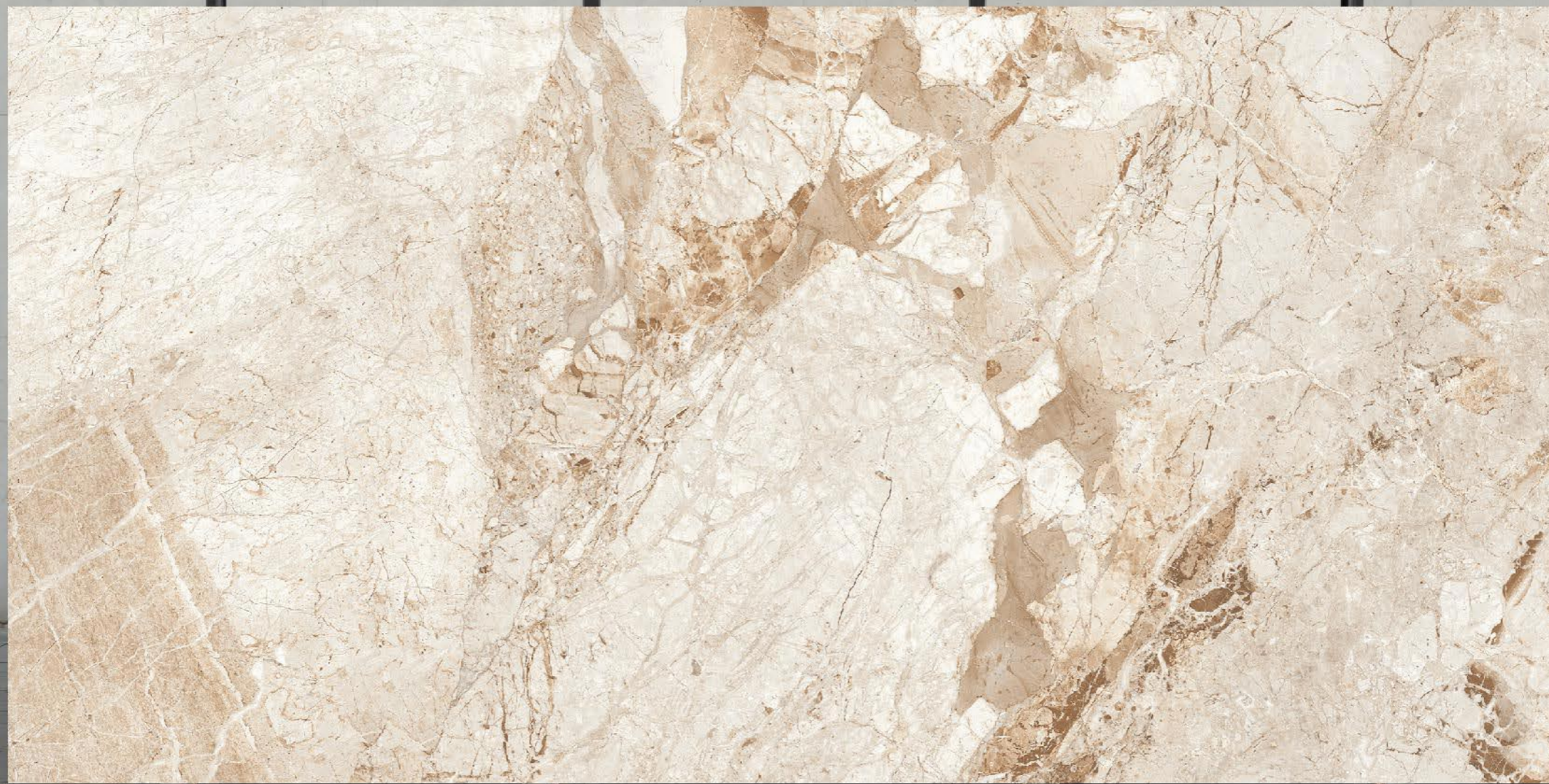

BRECCIA AURORA

BODY
IVORY BODY

FINISH
GLOSSY

SIZE
1200x2400 MM

THICKNESS
15 MM

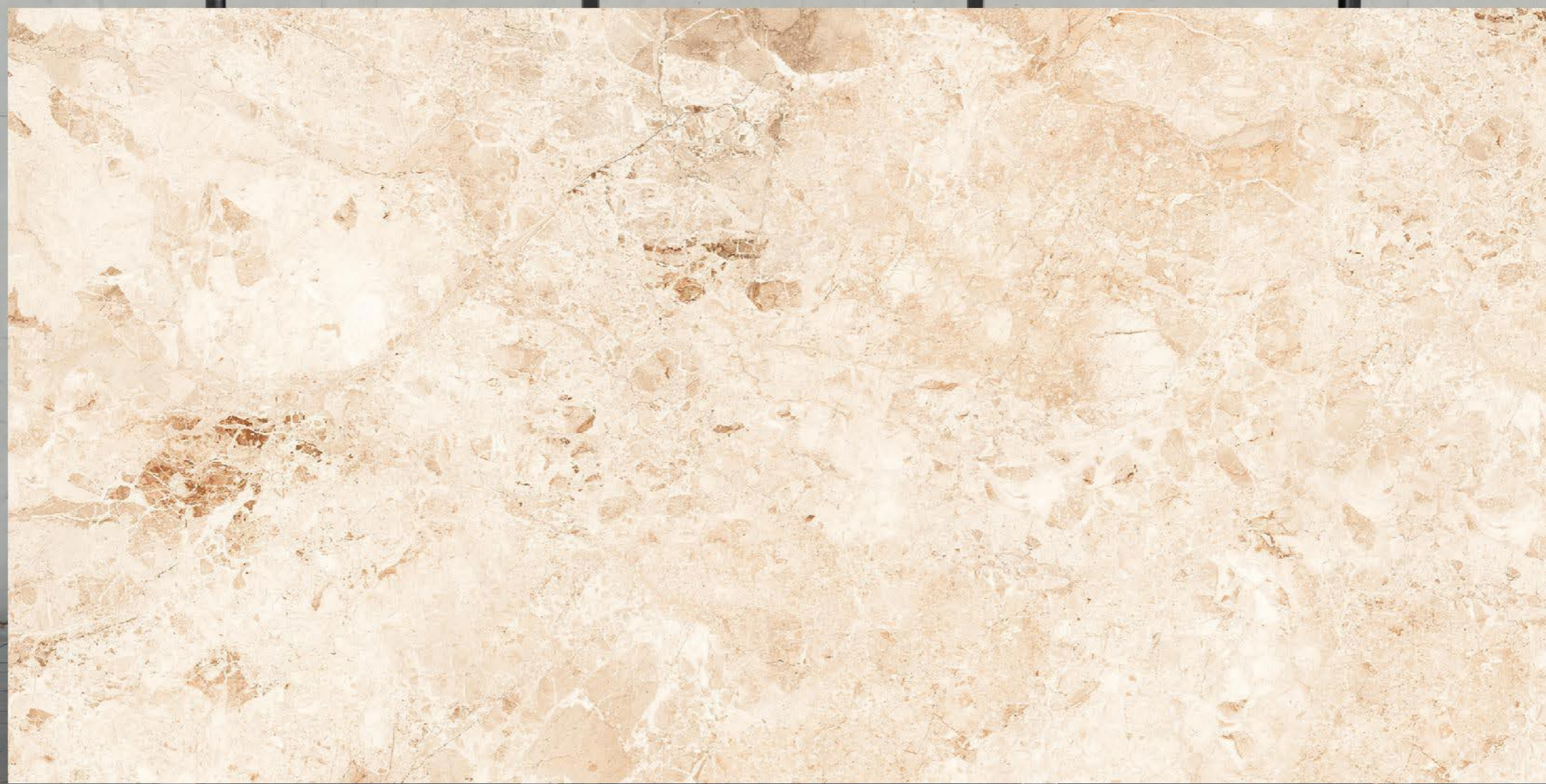

BRESSIA ONICIATA

BODY
IVORY BODY

FINISH
GLOSSY

SIZE
1200x2400 MM

THICKNESS
15 MM



MARFIL VALENCIA

BODY
IVORY BODY

FINISH
GLOSSY

SIZE
1200x2400 MM

THICKNESS
15 MM



ROCERSA IMPERIALE

BODY
IVORY BODY

FINISH
GLOSSY

SIZE
1200x2400 MM

THICKNESS
15 MM



TRANI FIORITO

BODY
IVORY BODY

FINISH
GLOSSY

SIZE
1200x2400 MM

THICKNESS
15 MM



ANTRESIT BIANCO

BODY
WHITE BODY

FINISH
GLOSSY

SIZE
1200x2400 MM

THICKNESS
15 MM

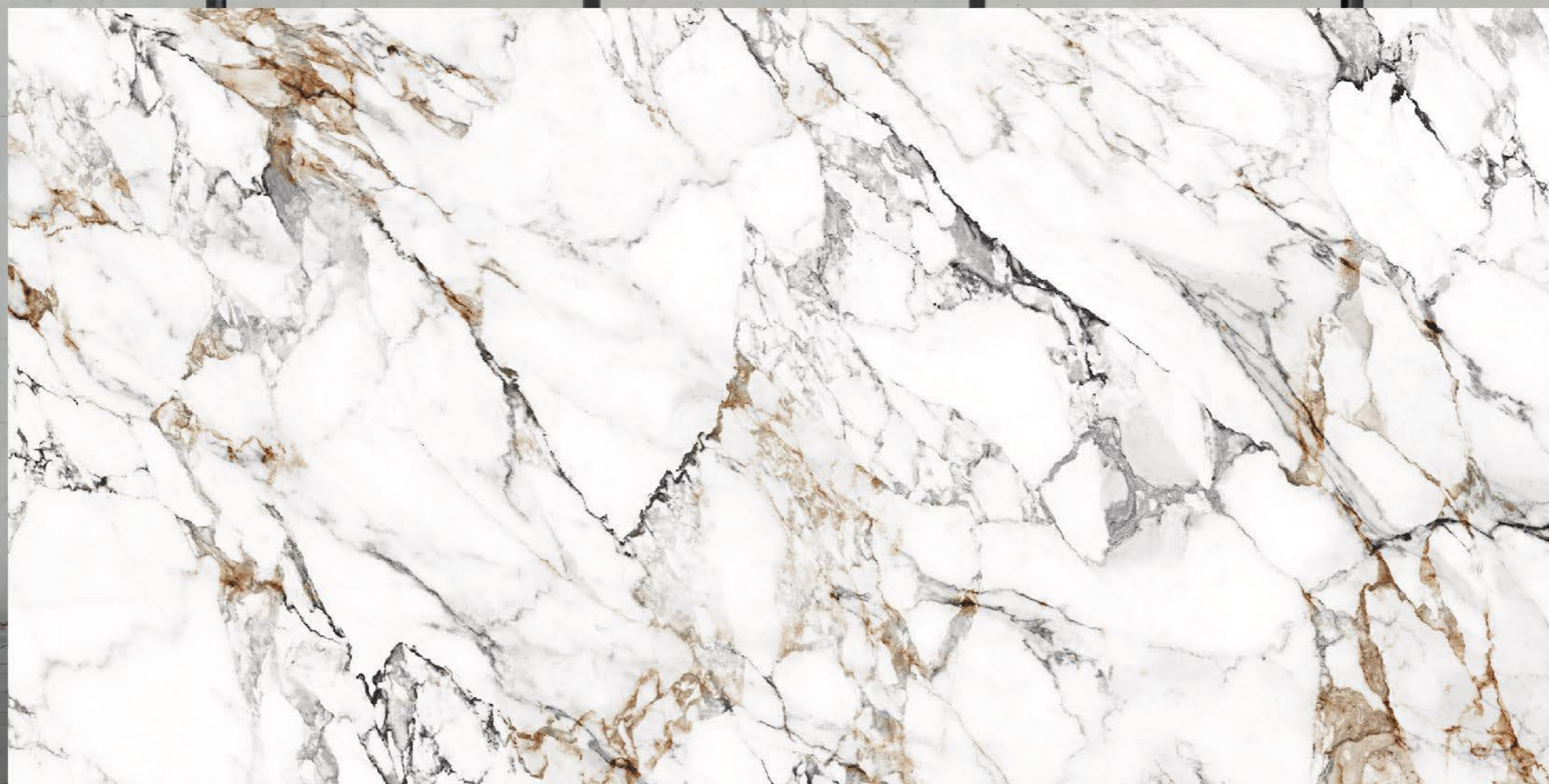

ARABESCATO GOLD

BODY
WHITE BODY

FINISH
GLOSSY

SIZE
1200x2400 MM

THICKNESS
15 MM

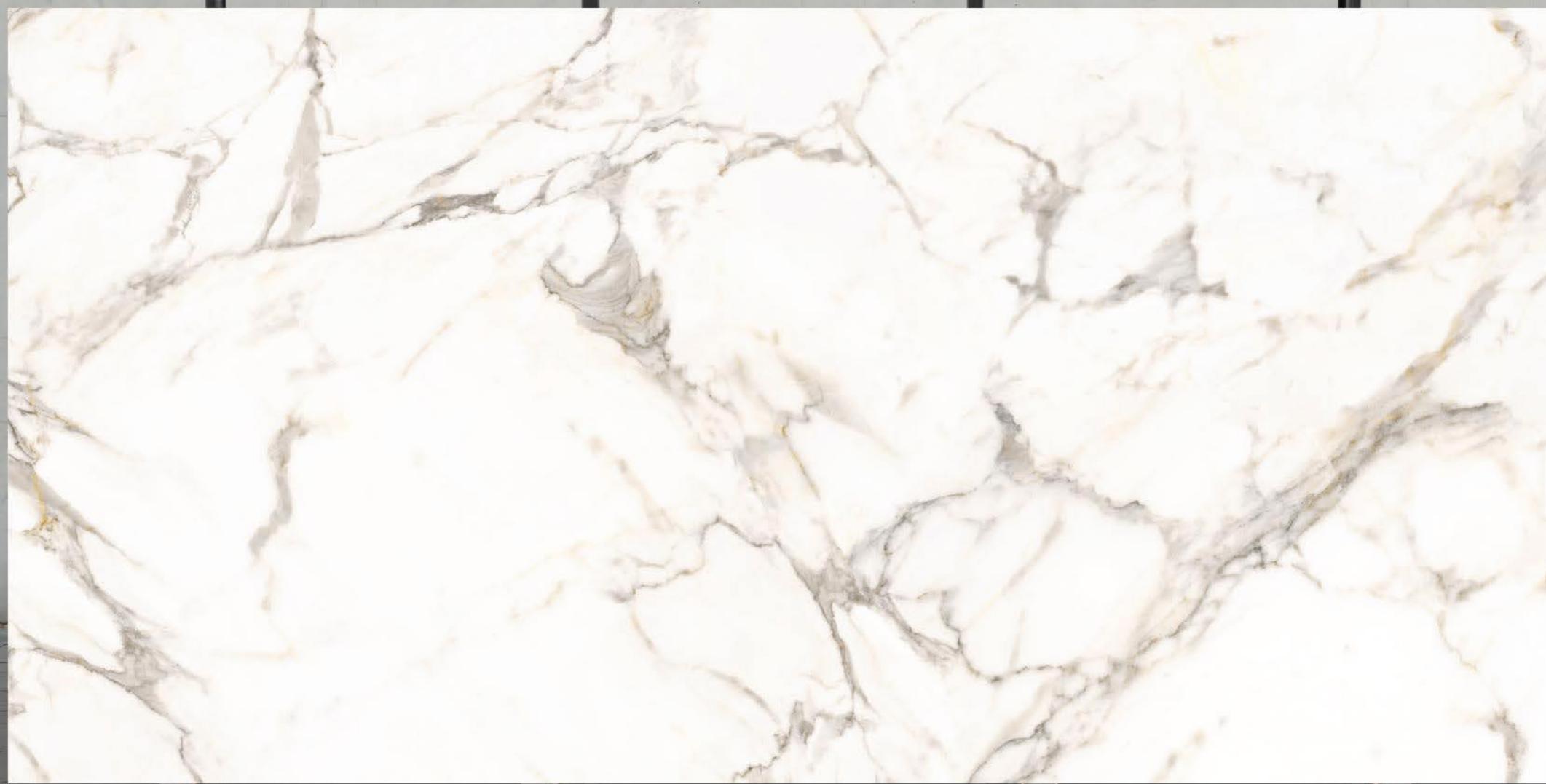

BIANCO CARRARA

BODY
WHITE BODY

FINISH
GLOSSY

SIZE
1200x2400 MM

THICKNESS
15 MM

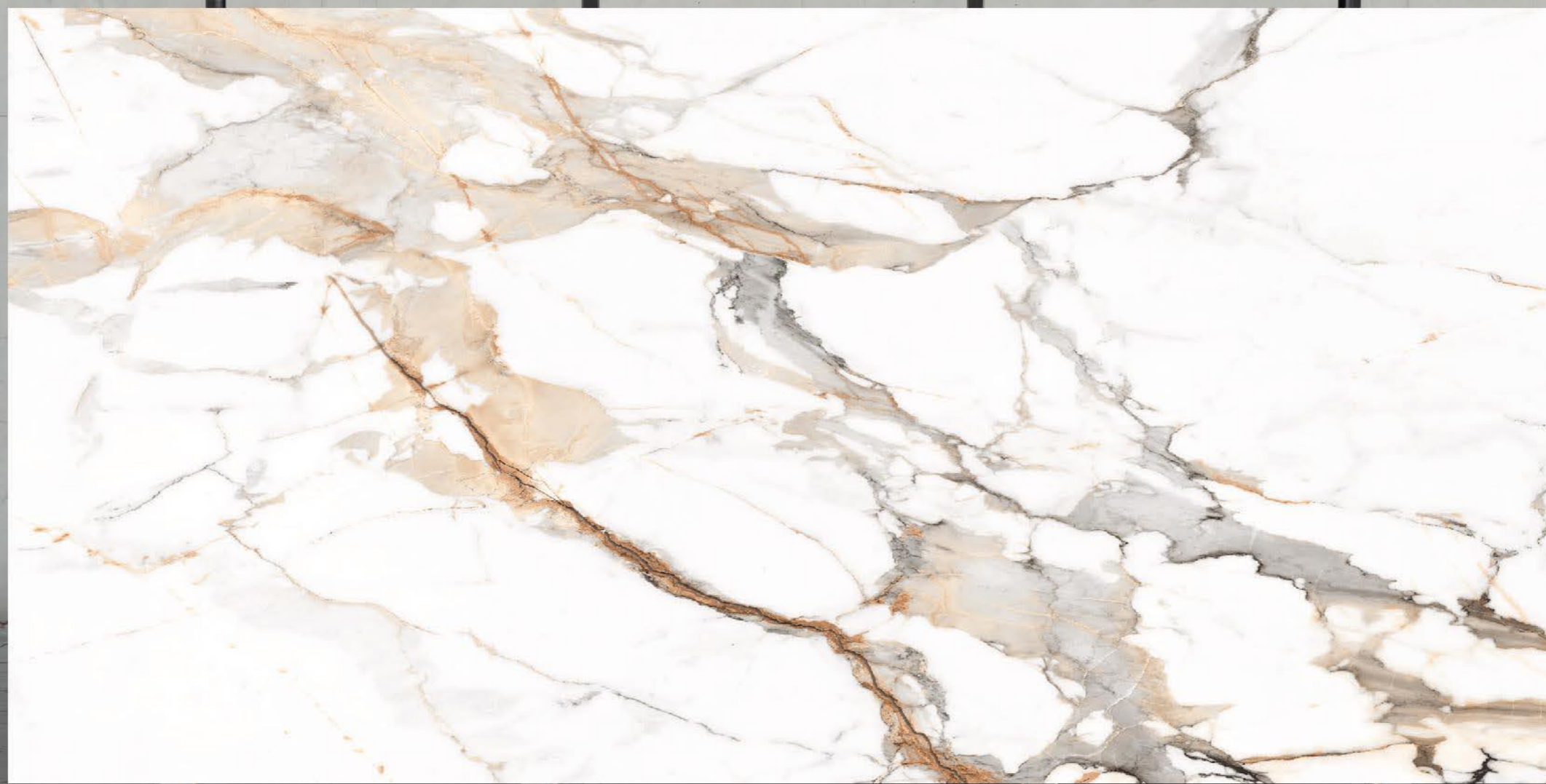

CALCATA ULTRA

BODY
WHITE BODY

FINISH
GLOSSY

SIZE
1200x2400 MM

THICKNESS
15 MM



GRIS MONCERVETTO

BODY
WHITE BODY

FINISH
GLOSSY

SIZE
1200x2400 MM

THICKNESS
15 MM



MONT BLANC

BODY
WHITE BODY

FINISH
GLOSSY

SIZE
1200x2400 MM

THICKNESS
15 MM

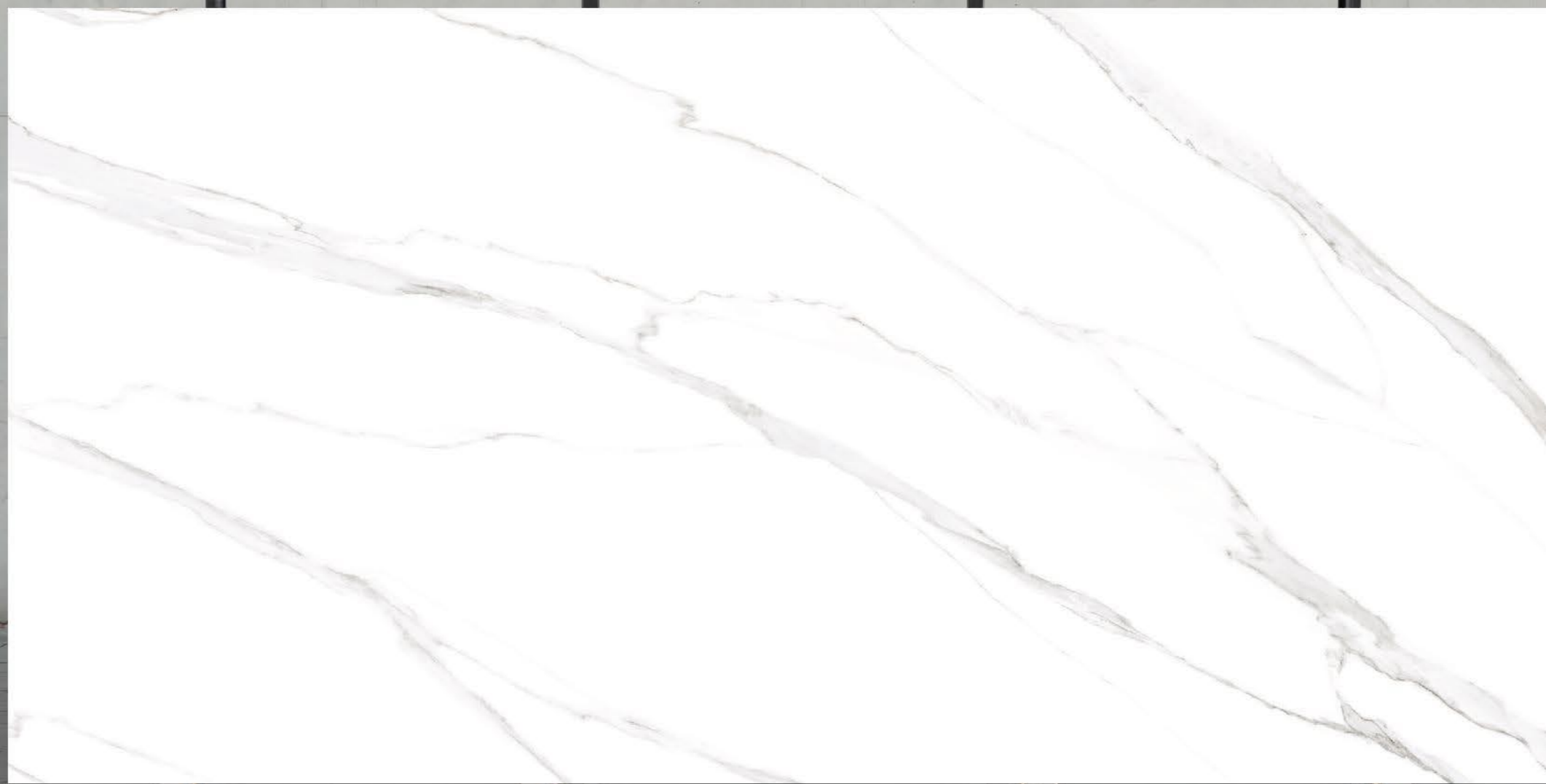

SATUARIO PEARL

BODY
WHITE BODY

FINISH
GLOSSY

SIZE
1200x2400 MM

THICKNESS
15 MM



STATUARIO DELICATO

BODY
WHITE BODY

FINISH
GLOSSY

SIZE
1200x2400 MM

THICKNESS
15 MM

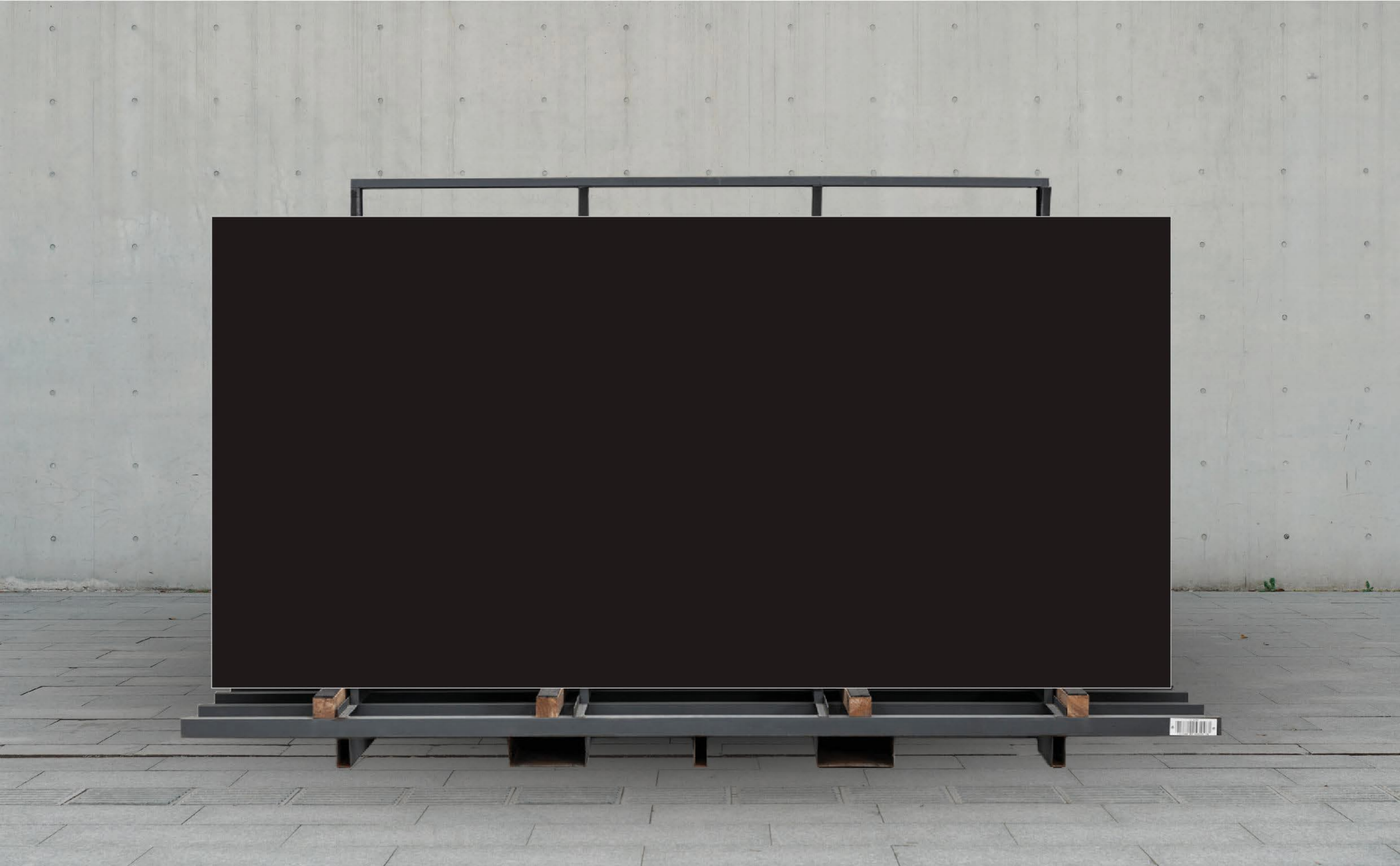

JET BLACK

BODY
FULL BODY

FINISH
GLOSSY & MATT

SIZE
1200x2400 MM

THICKNESS
15 MM

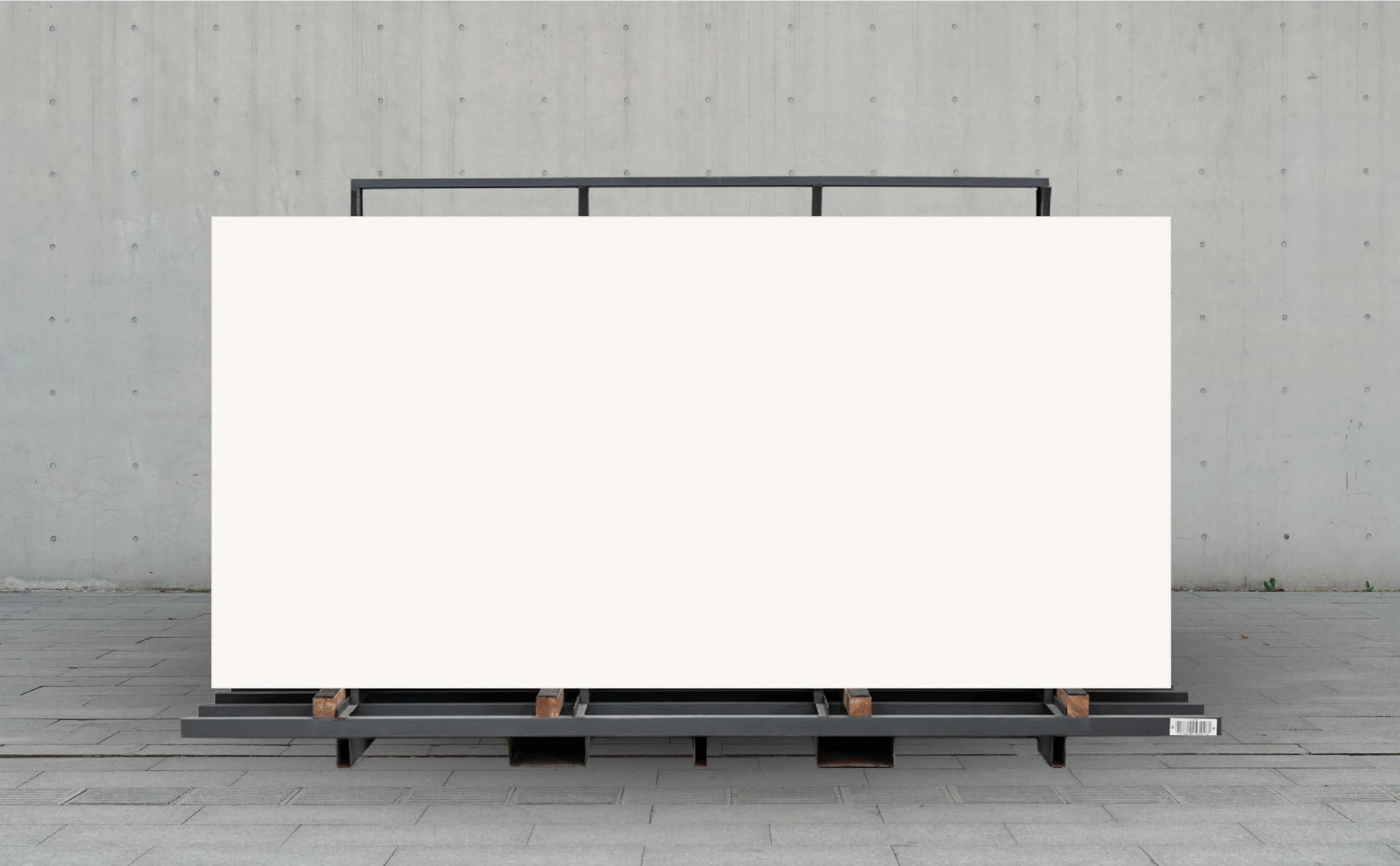

PEARL WHITE

BODY
FULL BODY

FINISH
GLOSSY & MATT

SIZE
1200x2400 MM

THICKNESS
15 MM



ROYAL QUARTZITE

BODY
FULL BODY

FINISH
GLOSSY & MATT

SIZE
1200x2400 MM

THICKNESS
15 MM

Cleaning & Maintenance

Our products are non porous (due to their high quality raw materials, stringent production parameters and state of the art technology), hence any dust or deposited waste cannot penetrate the surface.

For most cases only a damp cloth is sufficient for cleaning.

Regular cleaning highlights the aesthetic features of the surface and gives it exceptional shine.

For highly aggressive cleaning caused by some common food and substances follow the table below.

TYPE OF STAIN	CHEMICAL PRODUCT	EXAMPLE
Grease	Alkaline - Solvent	Detergent
Oil	Solvent	Ammonia, Baking Soda
Ink	Oxidant - Solvent	Alcohol, Liquid Bleach, Nail Paint Remover
Rust	Acid	Hydrochloric Acid, Vinegar, Red Harpic
Lime	Acid	Descaling Reagent, Hydro Chloric Acid
Cement	Acid	Hydro Chloric Acid
Wine	Alkaline	Ammonia, Liquid Bleach
Coffee	Alkaline - Solvent	Ammonia, Liquid Bleach
Rubber	Solvent	Alcohol, Thinner
Plaster	Acid	Hydro Chloric Acid
Candle Wax	Solvent	Alcohol, Thinner
Iodine	Oxidant	Liquid Bleach
Blood	Oxidant	Liquid Bleach
Ice Cream	Alkaline	Liquid Bleach

Note: It is recommended that any kind of stain needs to get clean immediately / as soon as possible.

Technical Specification

CHARACTERISTIC	STANDARD AS PER ISO13006:2018/ EN14411 Gr.B1a	MEAN VALUE OF IBIS	TEST METHOD
Regulatory Properties			
Deviation in Length and Width	± 0.30 % (±1.00mm)	± 0.10 %	ISO 10545-2
Deviation in Thickness	± 5.00 % (±0.50mm)	± 5.00 %	ISO 10545-2
Straightness in Side	± 0.30 % (±0.80mm)	± 0.10 %	ISO 10545-2
Rectangularity	± 0.30 % (±1.50mm)	± 0.10%	ISO 10545-2
Surface Flatness Central Curvature	± 0.40 % (±1.80mm)	± 0.50 %	ISO 10545-2
Surface Flatness Edge Curvature	± 0.40 % (±1.80mm)	± 0.50 %	ISO 10545-2
Surface Flatness Warpage	± 0.40 % (±1.80mm)	± 0.50 %	ISO 10545-2
Surface Quality	> 95% defects free	> 95% defects free	ISO 10545-2
Small Color Difference(for Plain Colour)	ΔE < 1.00	ΔE < 0.30	ISO 10545-16
Glossiness (Polished)	as per mfg.	Gloss Value> 90	Gloss Meter 60°
Glossiness (Matt)	as per mfg.	3 <Gloss Value<7	Gloss Meter 60°
Glossiness (Satin/Posh)	as per mfg.	7<Gloss Value<18	Gloss Meter 60°
Structural Properties			
Water absorption	≤ 0.50 %	≤ 0.060 %	ISO 10545-3
Bulk density	as per mfg.	Min. 2.28 g/cc	ISO 10545-3
Massive Mechanical Properties			
Modulus of rupture	Min. 35.0 N/mm ²	Min. 42.0 N/mm ²	ISO 10545-4
Breaking strength thickness <7.5	Min. 7000.0 N	Min. 10000.0 N	ISO 10545-4
Breaking strength thickness ≥7.5	Min. 13000.0 N	Min. 18000.0 N	ISO 10545-4
Breaking strength thickness ≥7.5mm)	Min. 13000.0 N	Min. 75000.0 N	ISO 10545-4
Surface Mechanical Properties			
MOH'S hardness #	as per mfg.	Glossy Min. 4*/ Posh Min. 6	BS EN 15771
Surface abrasion resistance #	as per mfg.	Glossy Min. 2/ Posh Min. 3	ISO 10545-7
Deep abrasion resistance #	Max. 175m ³ m	Max. 132m ³ m	ISO 10545-6
Thermal Hydrometric Properties			
Moisture expansion	Max. 0.06%(0.6mm/m)	Max. 0.02mm/m	ISO 10545-10
Thermal expansion(COE) at 100°C	as per mfg.	Max. 6.0 x 10 ⁻⁶	ISO 10545-8
Thermal shock resistance	Min. 10 Cycle	Min. 10 Cycle	ISO 10545-9
Impact resistance(COR) #	Min. 0.55	Min. 0.55	ISO 10545-5
Frost resistance	as per mfg.	Frost Proof	ISO 10545-12
Chemical Properties			
Resistance to staining glazed	Min. Class 3	Min. Class 4	ISO 10545-14
Resistance to household chemicals & swimming pool salts glazed	Min. Class GB	Min. Class GA	ISO 10545-13
Resistance to low concentrate acid and alkalis glazed	as per mfg.	Min. Class GLB**	ISO 10545-13
Resistance to high concentrate acid and alkalis glazed	as per mfg.	Min. Class GHB**	ISO 10545-13
Safety Properties			
Skid resistance(DCOF-DRY) ##	as per mfg.	Glossy P0(< ¹³) / Posh ≥P1(¹²⁻¹⁴)	BS 7976-2
Slip resistance(DCOF)(R value) ##	as per mfg.	R9 to R13	DIN 51130
Fire resistance	as per mfg.	Fire Proof	N.A.

* With Nano polished
 ** Except Hydrofluoric Acid & it's compound
 # Tiles intended for use on floor
 ## As per customer requirement

Packing Details

PRODUCT	BODY	SIZE	THICKNESS	TILES / BOX	COVERAGE AREA / BOX	WEIGHT (Kg)
Glossy	Color Body	1200x2400mm	15mm	1pc	31 Sq ft	98 to 100 Approx
Glossy & Matt	Full Body	1200x2400mm	15mm	1pc	31 Sq ft	98 to 100 Approx